

IN-SIGHT LASER PROFILER

The In-Sight® laser profiler is a measurement system used to verify that a part's dimensions meet specifications. The In-Sight laser profiler is configured using the In-Sight EasyBuilder® user interface. This intuitive, easy-to-use software makes it simple for manufacturing and quality engineers to develop, deploy and support high accuracy measurements on the factory floor.

The In-Sight laser profiler is set up and deployed in 4 easy steps:

1. Acquire Profile

The ability to produce an accurate profile of your part is critical to the success of any application. With a click of a button, profile optimization technology renders the most accurate outline of your part.

2. Locate Object

An inconsistent presentation of a part can directly result in measurement errors. Sophisticated object detection technology minimizes the need for costly fixturing and ensures measurements are performed in the correct location.

3. Measure

Factory engineers will be up and running within minutes using the In-Sight EasyBuilder user interface. The flexible In-Sight laser profiler toolset extracts features, constructs reference points and verifies whether a product has been manufactured within tolerance.

4. Communicate Results

Once results have been achieved, measurements are sent to a PLC or an overall pass/fail is sent directly as a discrete output.



DS1000 Series Laser
Displacement Sensor

In-Sight VC200 Multi Smart
Camera Vision Controller

How a Laser Profiler Works

The In-Sight laser profiler generates an accurate 2D profile of an object along a laser line. The 2D profile provides precise geometric information that can be used to verify that an object is defect-free and meets specifications. The In-Sight laser profiler is easy to use and factory calibrated to ensure accurate and repeatable measurement results.

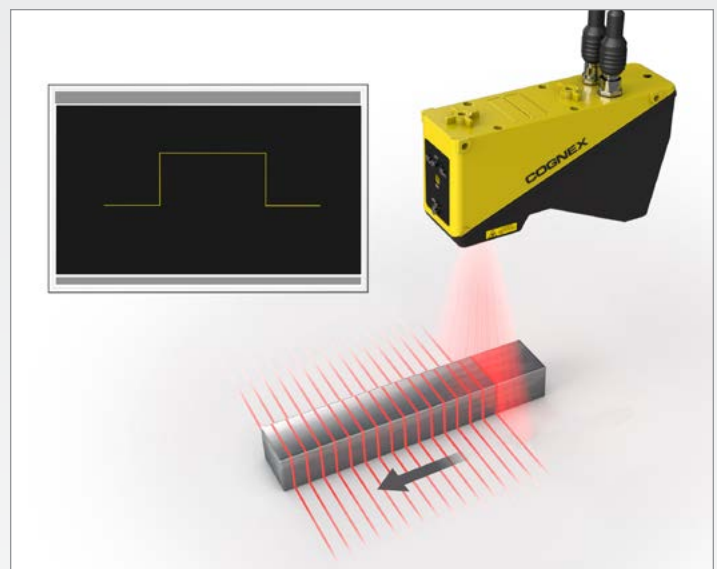

Simultaneous HMI Access

The In-Sight laser profiler offers mobile, platform-independent visualization for accessing HMIs (human machine interfaces) from anywhere on the network. An HTML-based user interface allows users to monitor production line activity from any laptop, tablet, smart phone or other mobile device.

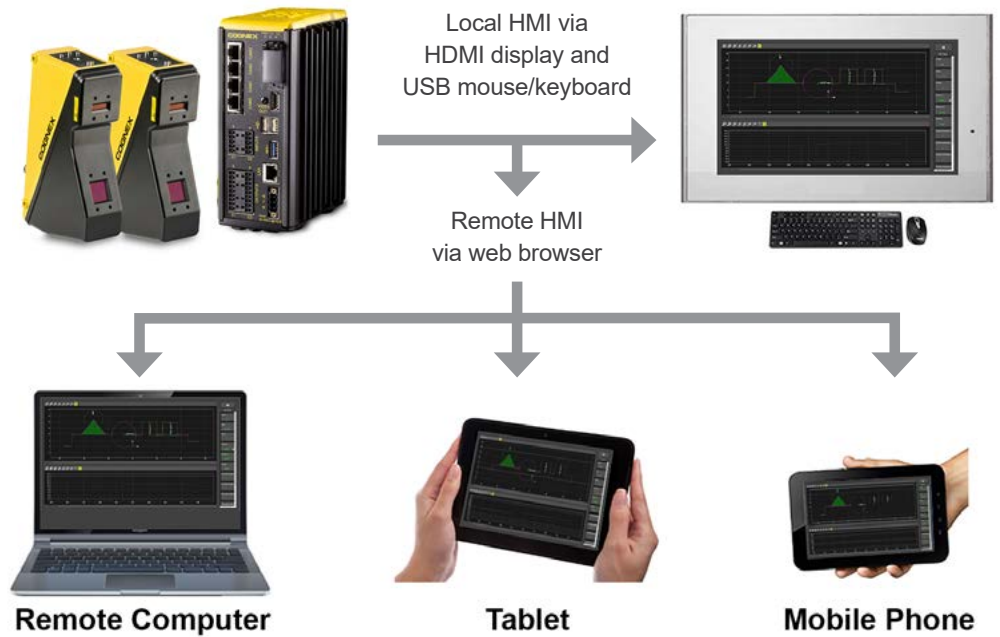

In-Sight VC200 Vision Controller

The In-Sight laser profiler is powered by the industrial In-Sight VC200 vision controller which stores and runs your measurement application.

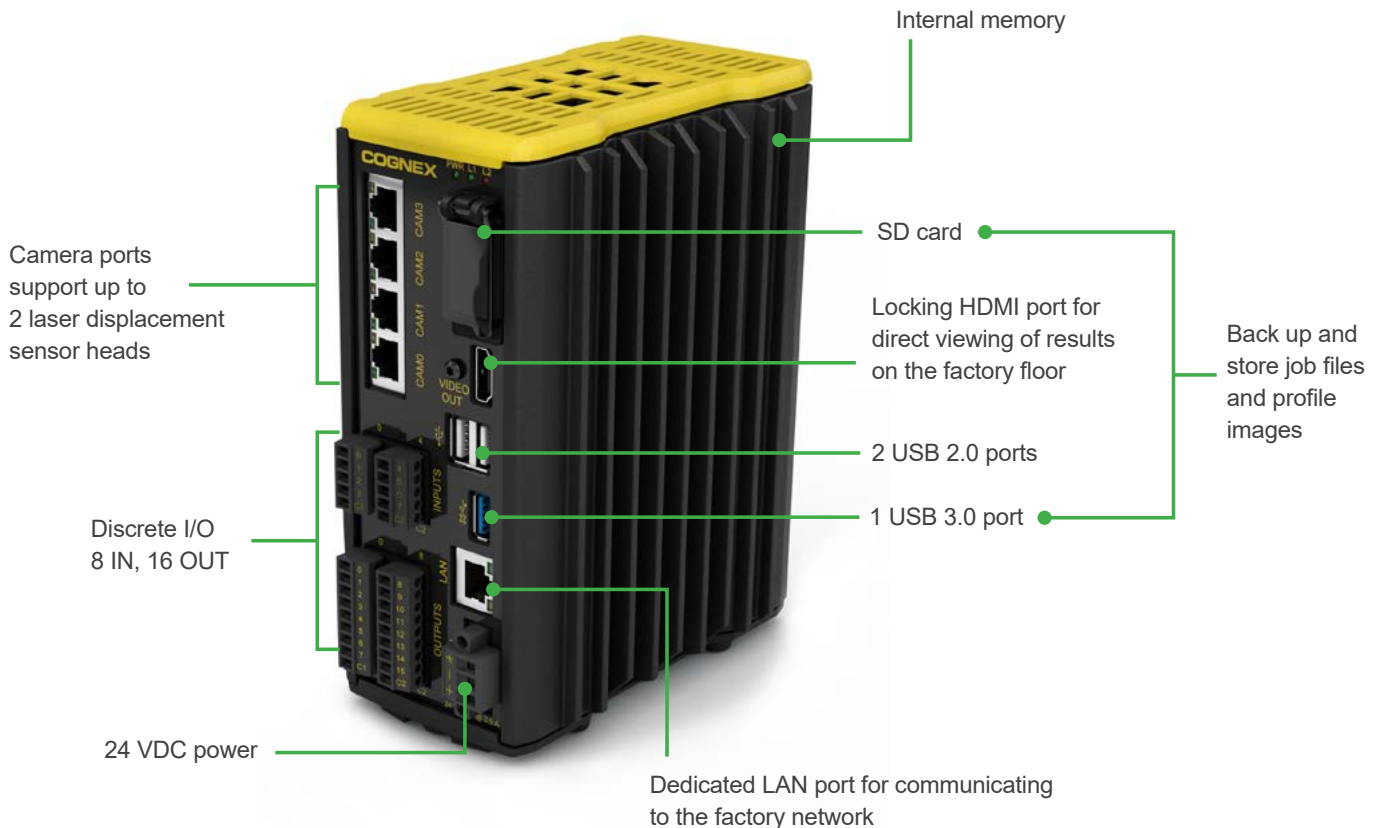

In-Sight Profiler Software and Vision Toolsets

The In-Sight laser profiler uses In-Sight VC Explorer with EasyBuilder to set up and monitor a variety of measurements. The intuitive interface guides operators through a step-by-step setup process allowing both novice and experienced users to configure measurement applications quickly and easily.

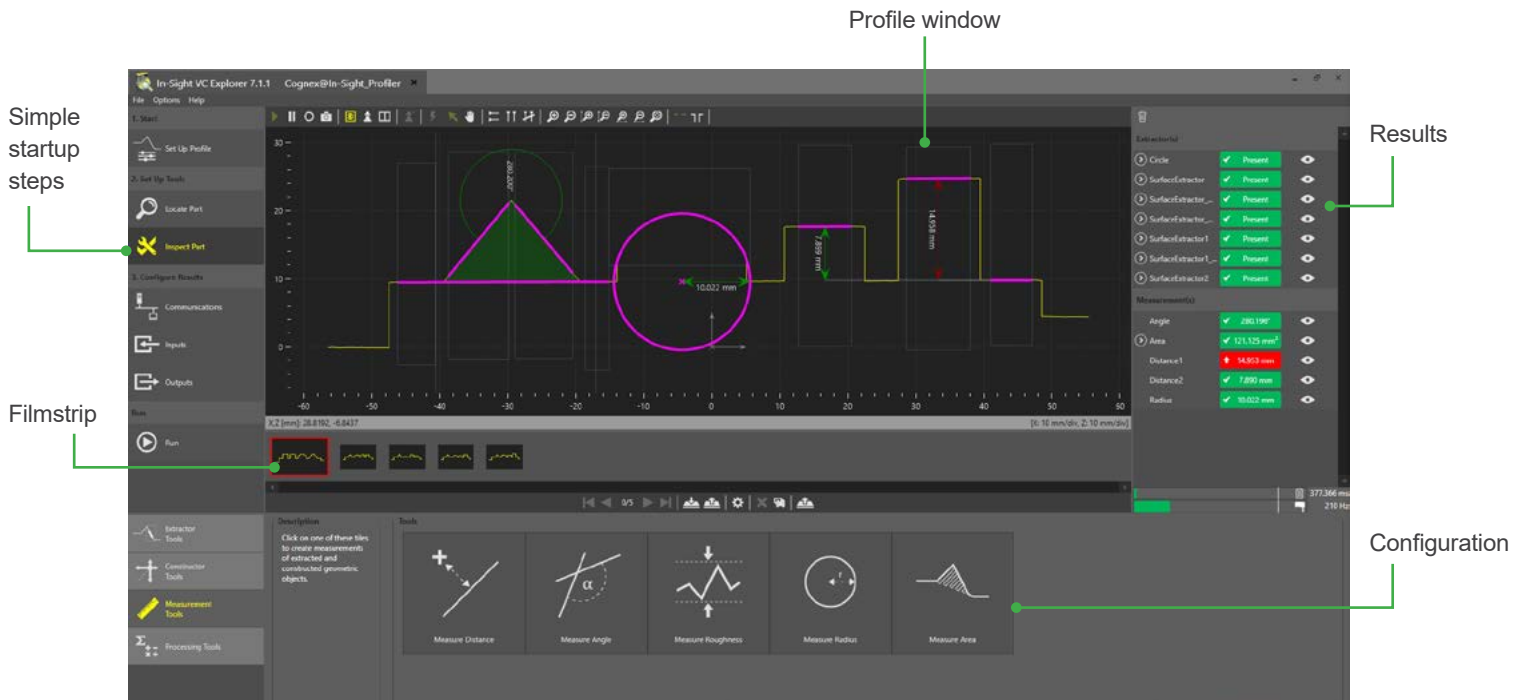

Sample part

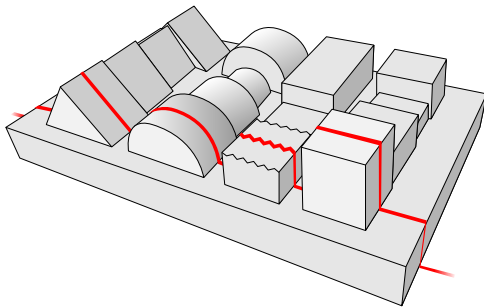

Extraction tools

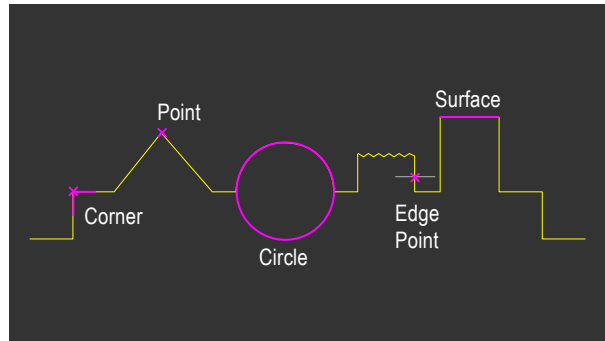

Construction tools

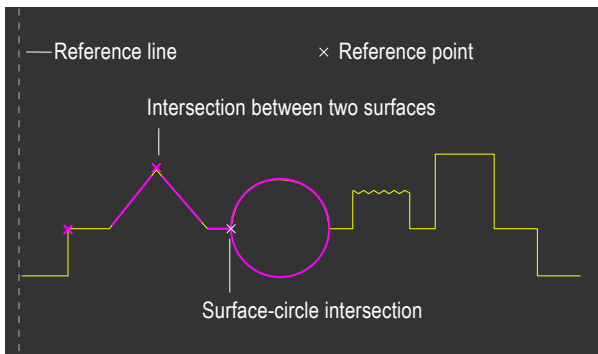

Measurement tools

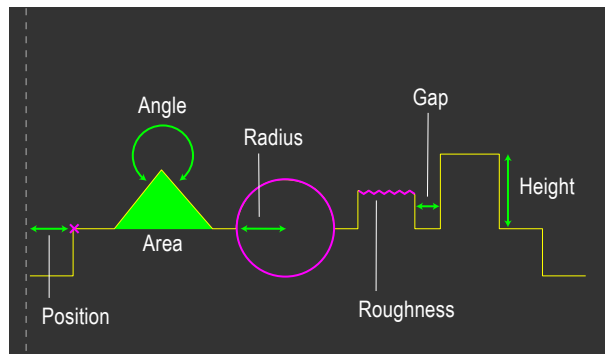

In-Sight Laser Profiler Solutions

Automotive solutions

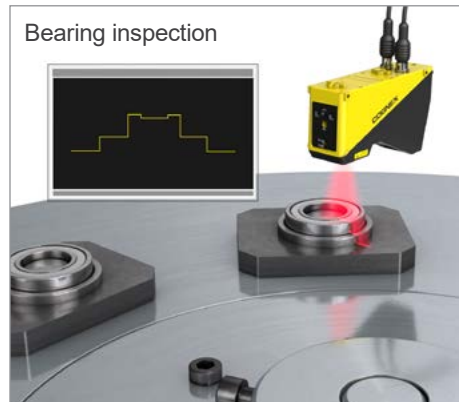
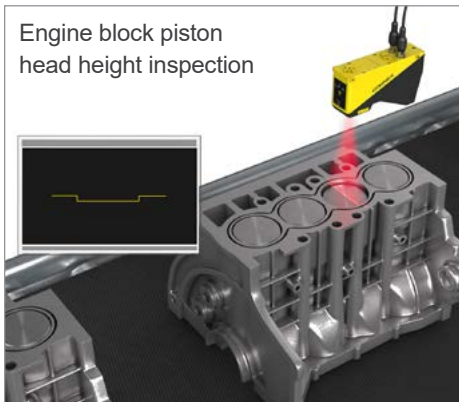
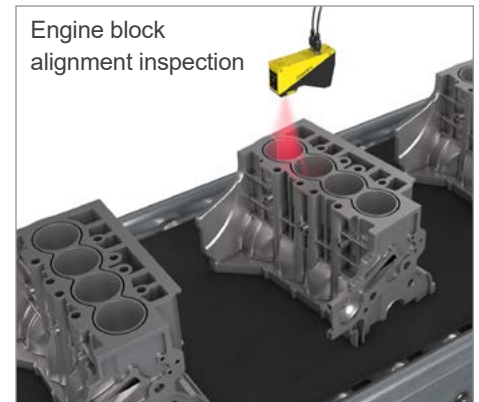
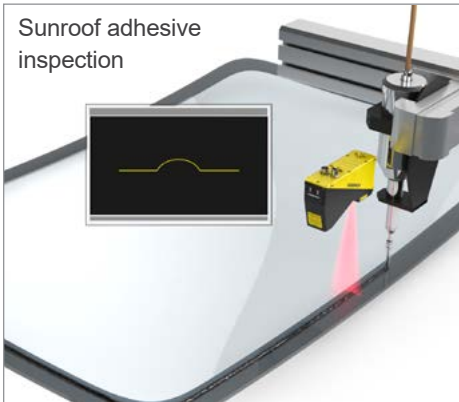
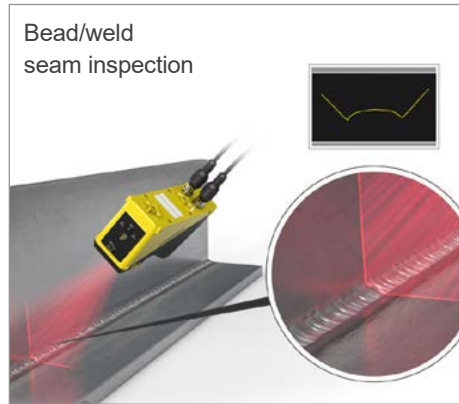
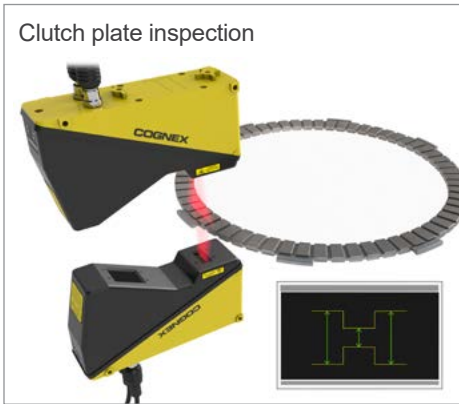
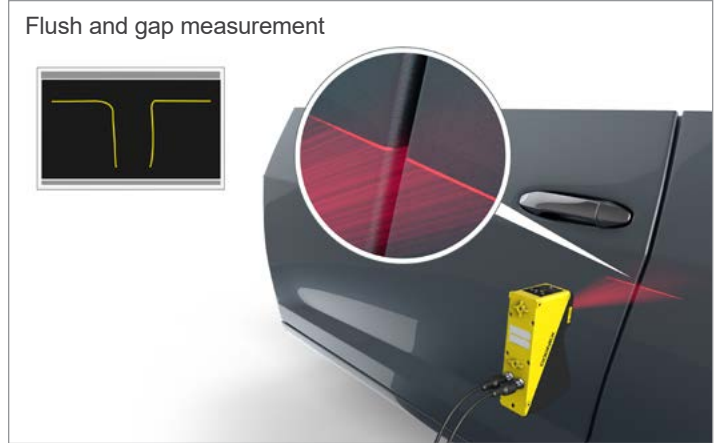
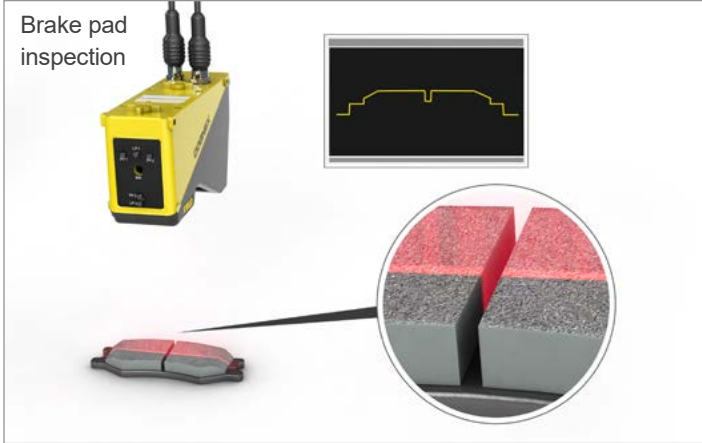

Consumer electronics solutions

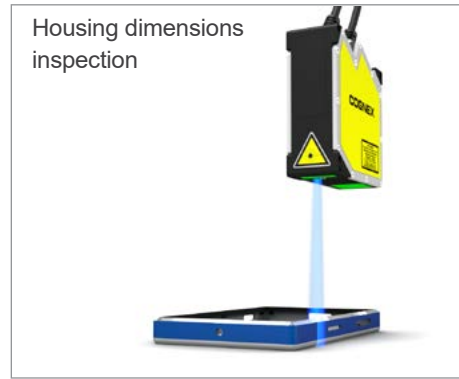
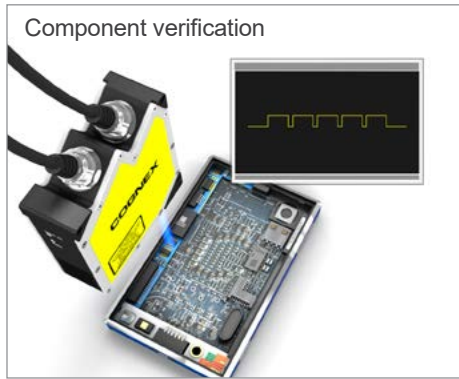

Consumer products solutions

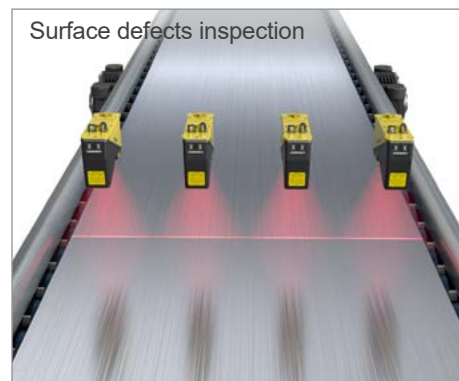
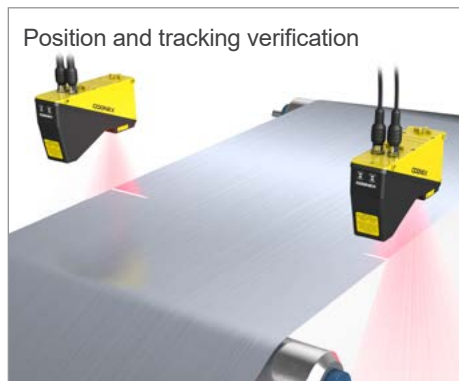
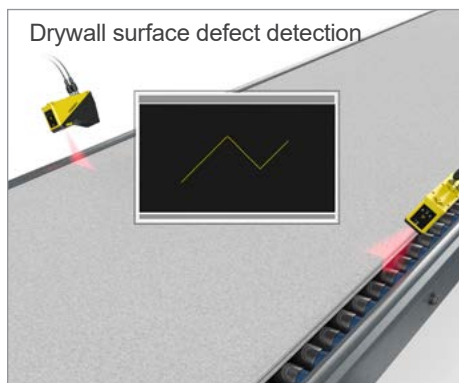

Food/beverage solutions



SPECIFICATIONS

	Vision Controller
Supported Cognex devices	DS1050, DS1101, DS1300, DS925B, DS910B
Job/program memory	8 GB non-volatile flash memory. Unlimited storage via remote network device
Image processing memory	2 GB SDRAM
Cooling system	Fanless design
Inputs	8 optically isolated discrete inputs
Outputs	16 optically isolated discrete outputs
Camera ports ¹	2 RJ-45 dedicated Ethernet ports for connecting directly to support laser displacement sensor heads, additionally supplying Power over Ethernet ⁵
LAN port ²	1 RJ-45 Ethernet port, 10/100/1000 BaseT with auto MDIX. IEEE 802.3 TCP/IP Protocol. Dedicated port for connecting to wide area network
USB ports ³	1 host USB 3.0 port (5 Gb/sec.) and 2 host USB 2.0 ports (480 Mb/sec.) ports for connecting storage device. USB drives should be formatted with a FAT32 file system
SD card slot	1 SD card slot for saving images, run time files and results. SD cards should be UHS-I or UHS-II and formatted with a FAT32 file system
Video out port	1 locking HDMI port that provides connection to a display device
I/O terminal connectors	16–26 AWG, solid or stranded wire. Torque 0.25 Nm (2.2 in-lb)
24 VDC power connector	14–18 AWG, solid or stranded wire. Torque 0.6 Nm (5.3 in-lb)
Status LEDs	PWR LED, LED 1, LED 2
Housing	Aluminum, steel sheet metal, injection-molded housing
Mounting	Four bottom and four backside M4 x 0.7 threaded mounting holes. The vision controller may be optionally mounted using the accessory wall mounting bracket (BKT-WALL-VC200-01) or to a 35x15 mm DIN rail, using the accessory DIN rail mounting bracket (BKT-DIN-VC200-01)
Dimensions	178.8 mm (7.04 in) x 142.1 mm (5.59 in) x 75.1 mm (2.96 in)
Weight	1.45 kg (3.2 lb)
Current	3.5 A (maximum)
Voltage	24 VDC ±10%
Power consumption	84 W (maximum)
Operating temperature ⁴	0 °C to 45 °C (32 °F to 113 °F)
Storage temperature	-30 °C to 80 °C (-22 °F to 176 °F)
Humidity	10%–85%, non-condensing (Operating and Storage)
Altitude	2,000 m (6565 ft)
Protection	IP30
Shock (storage and shipment)	30 G, per IEC 60068-2-7EA
Vibration (storage and shipment)	2 G, 2 hrs/axis (10-500 Hz) per IEC 60068-2-6, FC
Regulatory compliance	CE, FCC, KCC, TÜV SÜD NRTL, RoHS

¹ To ensure reliable communication using 1000 BaseT operation, the Ethernet cable must not exceed 100 meters.

² To ensure reliable communication using 1000 BaseT operation, the Ethernet cable must not exceed 100 meters.

³ Maximum USB port speeds are listed. Actual speeds are dependent on the USB device, which are typically lower.

⁴ To ensure sufficient ventilation, the vision controller must be mounted with 50 mm of clearance above the vision controller and 50 mm of clearance on both sides. If an adjacent device also produces heat, additional space or cooling is required if air space around the vision controller exceeds 45 °C (113 °F).

⁵ DS925B and DS910B heads only.

SPECIFICATIONS

	DS1050, DS1101 and DS1300
Dimensions	93.3 mm to 115.2 mm (H) x 50 mm (W) x 167.06 mm (L)
Weight	700 g
Operating temperature	0 °C to 50 °C (32 °F to 113 °F)
Storage temperature	-10 °C to 60 °C (-14 °F to 140 °F)
Maximum humidity	85% (non-condensing)
Housing	IP65 (with Cognex recommended IP65 Ethernet and power I/O cables)
Shock	50 gs (11 ms half-Sine pulse)
Vibration	8 gs (10–500 Hz for 30 minutes)
Discrete I/O operating limits	Trigger input voltage limits: -24 VDC – +24 VDC Input ON: > 10 VDC (>6 mA) Input OFF: < 2 VDC (<1.5 mA)
Encoder input specifications	Differential: A+/B+: 5–24V (50 kHz max) A-/B-: Inverted (A+/B+) Single-ended: A+/B+: 5–24V (50 kHz max) A-/B-: +0 VDC=½(A+/B+)
Power supply	Voltage: +24 VDC (22–26 VDC) Current: 500 mA max
Scan rate	2.25 kHz
Software	In-Sight VC Explorer with EasyBuilder
Ethernet	Gigabit Ethernet interface Integrated link and traffic LEDs Standard M12-8 female connector
Certifications	
Accessories	Ethernet cable: 5m, IP65-rated Power: + I/O + Encoder cable, IP65-rated Mounting bracket Stainless steel enclosure, IP69K-rated for the food industry
VC200 Controller	High-speed embedded processor Precision I/O Real Time Communications 179 mm x 142 mm x 75 mm

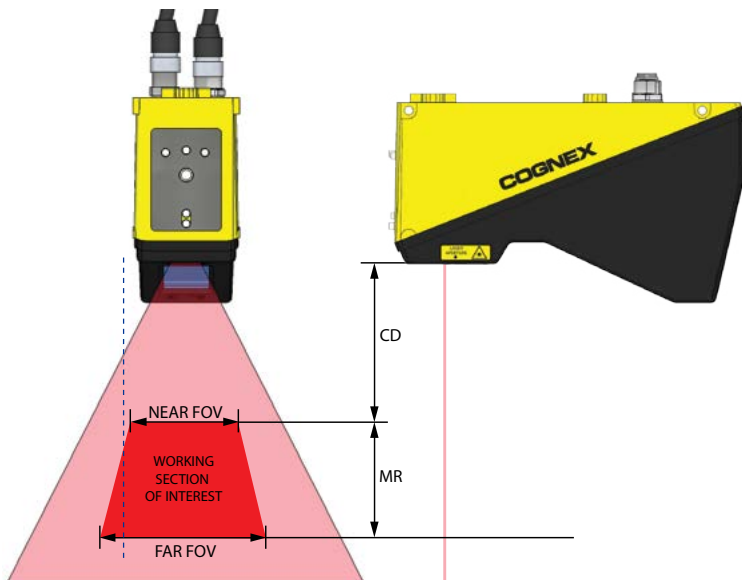

MODEL COMPARISON

	DS1050	DS1101	DS1300
Near Field of View (mm)	43	64	90
Far Field of View (mm)	79	162	410
Clearance Distance (mm)	87	135	180
Measurement Range (mm)	76	220	725
Laser Class	2M	2M	2M
Resolution X (mm)	0.042–0.077	0.063–0.158	0.088–0.410
Resolution Z (mm)	0.004–0.014	0.010–0.052	0.016–0.265
Linearity	±0.16% FS	±0.16% FS	±0.16% FS

SPECIFICATIONS

	DS910B and DS925B
Dimensions	96 mm (H) x 33 mm (W) x 85 mm (L)
Weight	380 g
Operating temperature	0 °C to 45 °C (32 °F to 113 °F)
Storage temperature	-20 °C to 70 °C (-4 °F to 158 °F)
Maximum humidity	5–95% (non-condensing)
Housing	IP65 (with Cognex recommended IP65 Ethernet and power I/O cables)
Laser power	8 mW (class 2M) 405 nm wavelength
Encoder input specifications	Single-ended quadrature encoder. A+/B+ voltage limits: +5 VDC (TTL); +30 VDC (HTL) Input ON: > 2.4 VDC (TTL); > 11 VDC (HTL) Input OFF: < 0.8 VDC (TTL); < 3 VDC (HTL) A-/B-: +0 VDC
Power supply	Voltage: +24 VDC (11–30 VDC) Current: 500 mA max IEEE 802.3af Power over Ethernet
Scan rate	1.39 kHz
Software	In-Sight VC Explorer with EasyBuilder
Ethernet	Gigabit Ethernet interface Standard M12-8 female connector
Certifications	
Accessories	Ethernet cable: 5 m, IP65-rated Power: + I/O + Encoder cable, IP65-rated
VC200 Controller	High-speed embedded processor Precision I/O Real Time Communications 179 mm x 142 mm x 75 mm

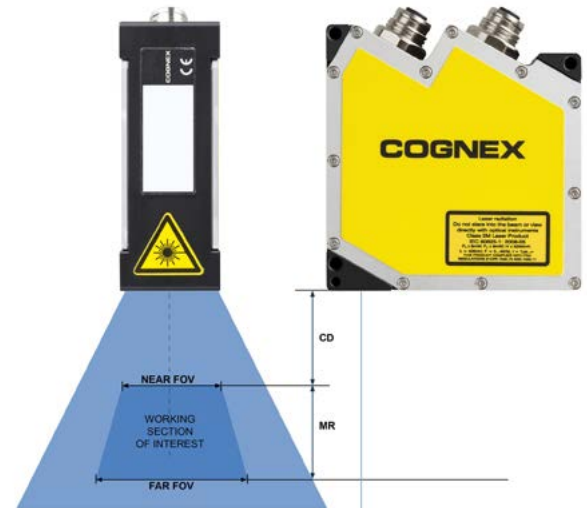

MODEL COMPARISON

	DS910B	DS925B
Near Field of View (mm)	9.4	23.4
Far Field of View (mm)	10.7	29.1
Clearance Distance (mm)	52.5	53.5
Measurement Range (mm)	8	25
Laser Class	2M	2M
Resolution X (mm)	0.0073–0.0084	0.0183–0.0227
Resolution Z (mm)	0.001	0.002
Linearity	±0.16% FS	±0.16% FS

COGNEX

Companies around the world rely on Cognex vision and barcode reading solutions to optimize quality, drive down costs and control traceability.

Corporate Headquarters One Vision Drive Natick, MA 01760 USA

Regional Sales Offices

Americas

North America +1 844-999-2469
Brazil +55 (11) 2626 7301
Mexico +01 800 733 4116

Europe

Austria +49 721 958 8052
Belgium +32 289 370 75
France +33 1 7654 9318
Germany +49 721 958 8052

Hungary +36 30 605 5480
Ireland +44 121 29 65 163
Italy +39 02 3057 8196
Netherlands +31 207 941 398
Poland +48 717 121 086
Spain +34 93 299 28 14
Sweden +46 21 14 55 88
Switzerland +41 445 788 877
Turkey +90 216 900 1696
United Kingdom +44 121 29 65 163

Asia

China +86 21 6208 1133
India +9120 4014 7840
Japan +81 3 5977 5400
Korea +82 2 539 9980
Singapore +65 632 55 700
Taiwan +886 3 578 0060

© Copyright 2017, Cognex Corporation.
All information in this document is subject to change without notice. All Rights Reserved.
Cognex, In-Sight and EasyBuilder are registered trademarks of Cognex Corporation. All other trademarks are property of their respective owners.
Lit. No. DSISLP-0317

www.cognex.com