



■ USER SECURITY

Do respect the power supply voltages and the connection terminals. Do not modify or dismantle all or part of the product. Do not connect or clean when power is on. Do not watch the lighting source directly, and follow the advice below :

- If the workstation enables it, interpose a filter that will stop the lighting radiation under fixed or adjustable frame between the source and the operator.
- When these measures cannot be implemented, supply the operators with glasses (class 4) available for sale at TPL Vision, or with a dedicated protective mask, that will stop the lighting radiation.
- Forbid or limit the direct access to the lighting source (exposure into the radiation axis).
- Establish a security perimeter so as to prevent the operators from approaching the lighting source beyond the recommendations of the manufacturer, as for eye irritation is concerned.
- In any case, ensure that the chosen means properly reduce the exposition quantities (features of screens or glasses to be chosen, according to the wavelengths that the operators are exposed to).

■ DIFFUSER & POLARISER (OPTIONAL KIT)

- Insert either the opaque or the satin diffuser into the bracket.
- Polarisation: insert clear window into bracket, remove film on polariser and apply polariser to the clear window within the bracket. Be careful, any fingerprints on the polariser can degrade the polarisation.
- Insert the bracket onto the TSPOT 1. Then, use the 2 fastening screws to secure the assembly.

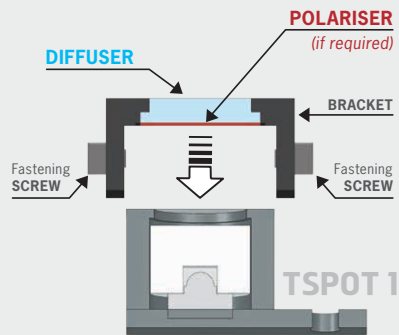

Ref.UG-040701-D3, 2020/1.0 edition.

■ EQUIPMENT MAINTENANCE

CLEANING (when the product is switched off)

Please use a soft and dry cloth. Do not use any abrasive material. Do not use any cleaning solvent or aggressive chemical product. TPL Vision recommends to use isopropyl alcohol.



Brenchley House, School Road
Charing, Kent TN27 0JW
United Kingdom

TPL VISION
IS AN **ISO 9001**
CERTIFIED MANUFACTURER

+44 (0)1738 310 392

contact@tpl-vision.co.uk

www.tpl-vision.com

Features and presentations liable to changes without notice.

PREAMBLE

This notice includes all the advice and warnings that enables a correct set up and a safe use of the product. TPL Vision can not be responsible for the bad use of the notice. If so, TPL Vision cancels the guarantee's effects.



■ UNPACKING

Products are packed in our factory, using suitable materials for a safe transport through the usual means of transportation, in France and internationally. However, a damaged package must be reported to the carrier on delivery. Hand-written reservations must be indicated on the delivery order. Moreover, please send a letter or an email to TPL Vision as soon as possible (up to 24 hours after the delivery). If the transportation damage has not been stipulated on the delivery order and reported to TPL Vision in time, the package will not be taken back nor exchanged. To open the package, do not use any cutting blade to avoid damaging the product(s). Please use the delivered accessories, if needed (do not use any other products or equivalents to replace the delivered accessories).

■ RISK CLASS

The EN-62471 norm about lighting fluxes enables the classification of led lightings in 4 distinct groups, according to their hazardousness degree. Please find below an indicative table, recapitulating the classes of risk for our standard products.

Colour	Class	Risk
White WHI, Green 525 nm, Red 630 nm	0	none
UV 405 nm, Blue 470 nm, IR 850 nm	1	low
UV 365 nm	2	moderate
UV 385 nm	3	high

In all cases, TPL Vision recommends the use of **the protection glasses** that are listed in its catalog.

For more information about photo-biological risks, do not hesitate to contact us.



THIN TSPOT 1 USER GUIDE

P2/4

P3/4



DIMENSIONS

	Length (mm)	Height (mm)	Width (mm)
	A	B	C
TSPOT1	23	20	13

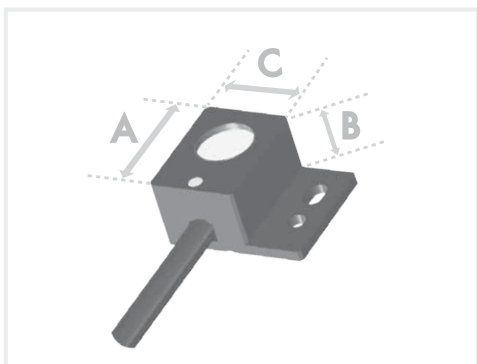

FIXING

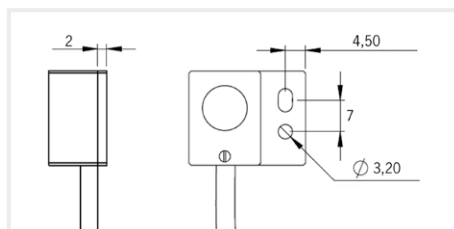

During the set up, the light has to be switched off and unplugged. Please use the fixing holes designed for that purpose (see scheme above). We recommend the using of M3 screws (not supplied) with a tightening torque from 0.5 to 1.5 Nm. We also recommend the use of a threadlocker (not supplied) to avoid any risk of loosening.

OPERATING CONDITIONS

Not for outdoor use.

CONTROL

DIMMING

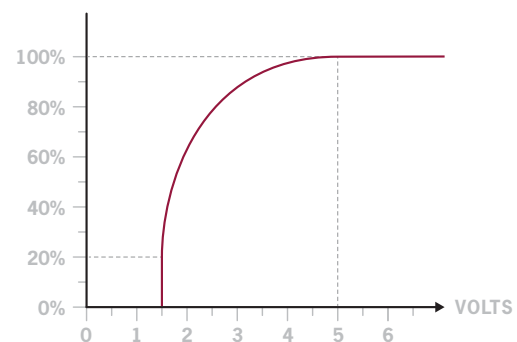

Potential dimming between 1.5 and 5 Volts.

Above 5 Volts, the product reaches 100% of its lighting power.

STROBE MODE

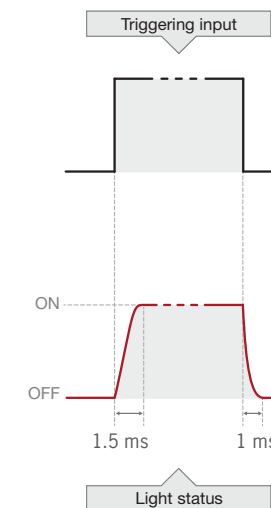

Power supply : 24V +/-10%
Strobe input : 24V or 5V TTL

CONNECTION

M12 4 male points

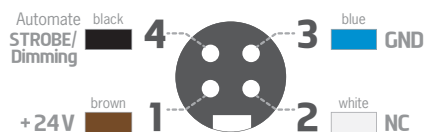

In STROBE mode:
STROBE entry = 24V
or 5V TTL -> light on

FRONT VIEW OF THE PRODUCT'S CONNECTOR

STROBE MODE CONNECTION



CONTINUOUS MODE CONNECTION

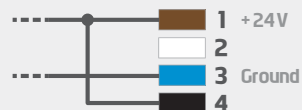

EXTERNAL DIMMING CONFIGURATION

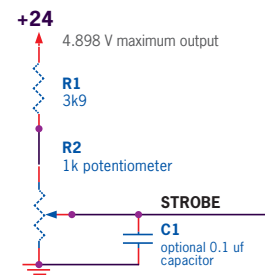

PNP-LIKE AUTOMATON OUTPUT

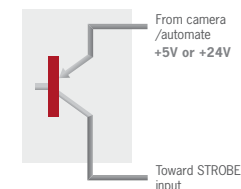

NPN-LIKE AUTOMATON OUTPUT

