



IN-SIGHT 2000

VISION SENSORS

THE GLOBAL LEADER

IN MACHINE VISION AND INDUSTRIAL BARCODE READING

Cognex, the world's most trusted machine vision and industrial barcode reading company.

With over 2 million systems installed in facilities around the world and over thirty seven years of experience, Cognex is focused on industrial machine vision and image-based barcode reading technology. Deployed by the world's top manufacturers, suppliers and machine builders, Cognex products ensure that manufactured items meet the stringent quality requirements of each industry.

Smarter automation using Cognex vision and barcode reading systems means fewer errors, which equates to lower costs and higher customer satisfaction. With the widest range of solutions and largest network of vision experts to meet the most challenging applications, Cognex is the best choice to help **Build Your Vision**.

**\$806
MILLION**
2018 REVENUE

OVER 37
YEARS IN THE BUSINESS

500+
CHANNEL PARTNERS

GLOBAL OFFICES IN
20+ COUNTRIES

2,000,000+
SYSTEMS SHIPPED





THE NEED FOR **AUTOMATED** INSPECTION

Increased throughput, higher quality, and lower costs are key drivers for automated inspection in manufacturing. Manual inspection can be slow, prone to errors, and often impossible considering the product size, lighting conditions, or line speed.

Given these factors, companies in a wide range of industries rely on vision sensors to perform simple pass/fail inspections that help ensure products and packaging are error-free and meet strict quality standards. Cognex vision sensors provide easy and reliable inspections thanks to powerful vision tools, integrated lighting, modularity, and an easy-to-use setup environment.



IN-SIGHT 2000 SERIES VISION SENSORS

The power, ease-of-use, and flexibility to solve any error-proofing application

Cognex In-Sight® 2000 series vision sensors combine the power of In-Sight vision systems with the simplicity and affordability of an industrial sensor. Ideal for error-proofing applications, these vision sensors set new standards for value, ease of use, and flexibility thanks to a powerful combination of proven In-Sight vision tools, simple setup, and a modular design featuring field-changeable lighting and optics.

- Intuitive EasyBuilder® interface allows even novice users to achieve reliable inspection performance in nearly any production environment
- Proven, reliable Cognex In-Sight vision tools
- Compact, modular design with field-changeable, integrated optics and lighting
- Autofocus lens eliminates the need to manually refocus or adjust the mounting height of the sensor during line changeovers
- Single-cable Power over Ethernet (PoE) models simplify installation

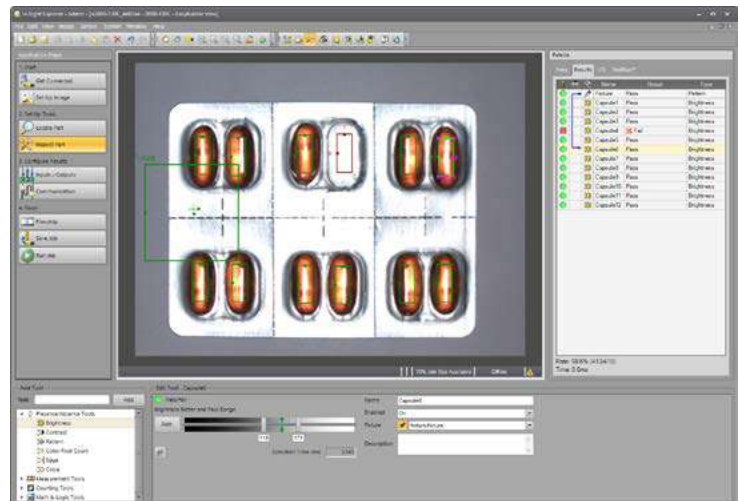

FAST, INTUITIVE SETUP WITH EASYBUILDER

The In-Sight Explorer™ EasyBuilder interface provides fast, step-by-step application setup that allows even novice users to achieve extremely reliable inspection performance in nearly any production environment. Intuitive, point-and-click setup tools accomplish basic pass/fail inspections. Users can create more complex inspection applications using In-Sight vision systems in the same In-Sight Explorer interface.

Simple steps help you configure and deploy your application

View the image in real time to set up lighting and add inspection tools

Choose tools from the list to add to your inspection

See inspection results at a glance

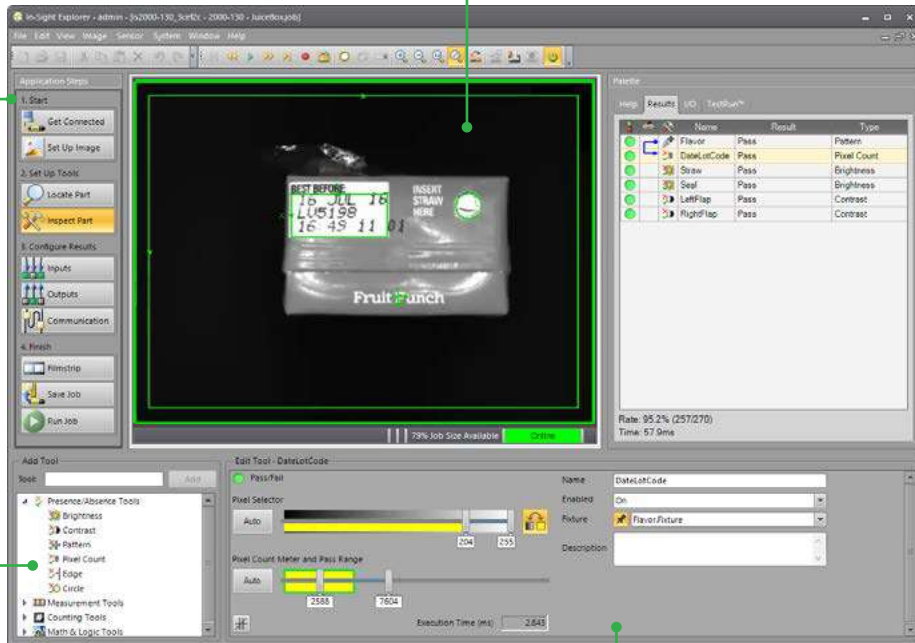

Point and click controls make it quick and easy to set up any tool to achieve reliable results

POWERFUL IN-SIGHT VISION TOOLS

The EasyBuilder interface provides access to a selection of powerful vision tools:

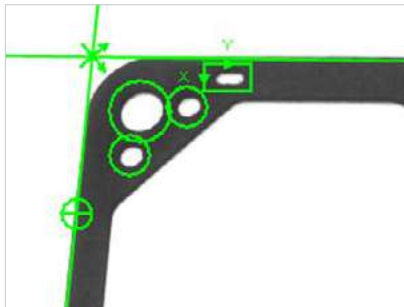

Location

Pattern, edge, and circle tools locate (or fixture) the part so other vision tools can use this as a reference to complete their inspections.

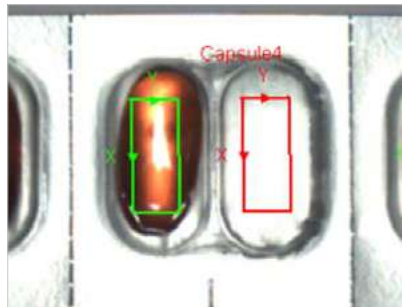

Presence/absence

Brightness, contrast, pattern, pixel count, edge, and circle tools determine the presence or absence of a part.

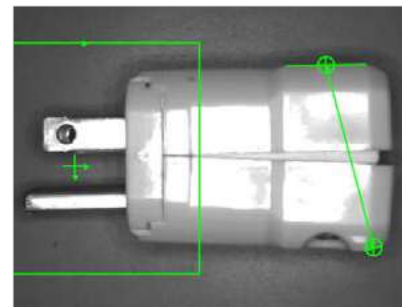

Measurement

Distance, angle, and circle diameter measurements verify a part's features are the correct size and in the correct position and orientation.

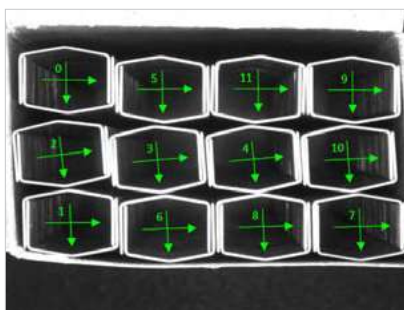

Counting

Counting patterns and edge features confirm the correct number of items are present on a conveyor or in a package.

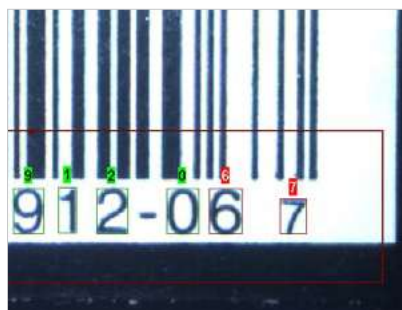

OCR*

Uses Cognex's OCRMax auto-tune feature to quickly and easily read high-quality characters on a variety of surfaces.



Blob*

Determines the presence or absence of non-uniform objects.

Image Filters*

More than 25 unique image filtering tools including binarize, edge magnitude, and stretch which can be used as a pre-processing step for subsequent vision tools.

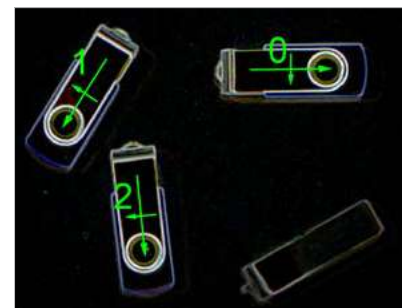
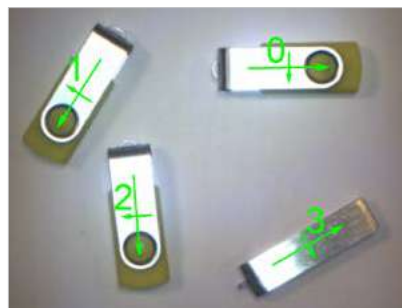

*Available on IS2000-230 and IS20001-230 models.

ELECTRONICS

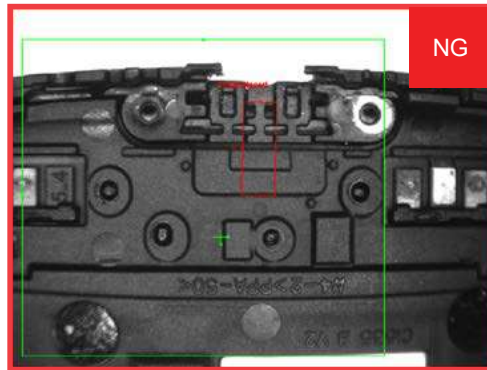
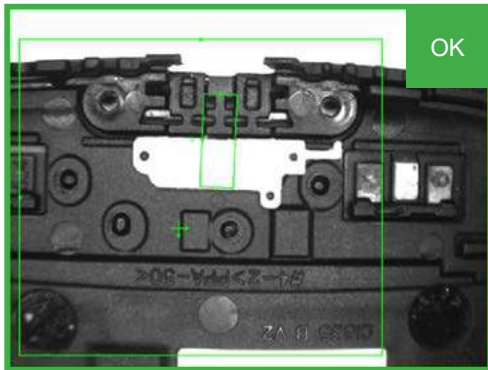

The presence of a rubber gasket attached to a molded plastic part is verified before an automated final assembly step.

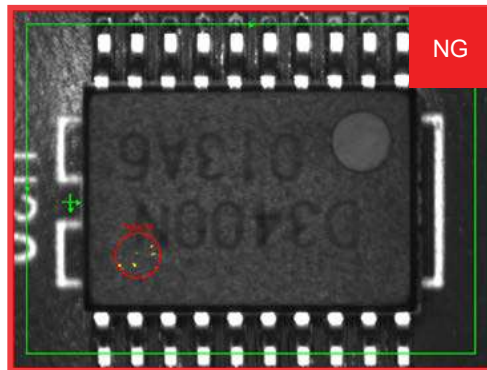
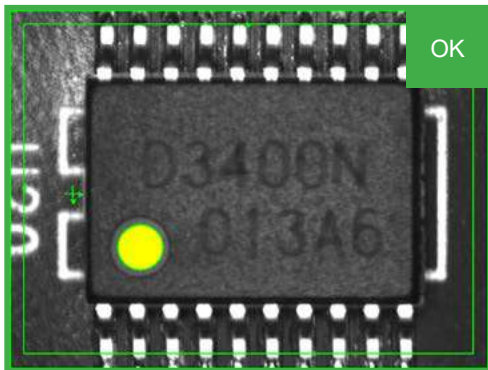

The presence of a fiducial is used to verify that an integrated circuit has been soldered onto the PCB in the correct orientation.

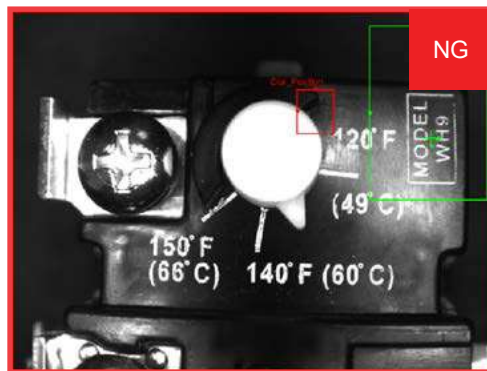
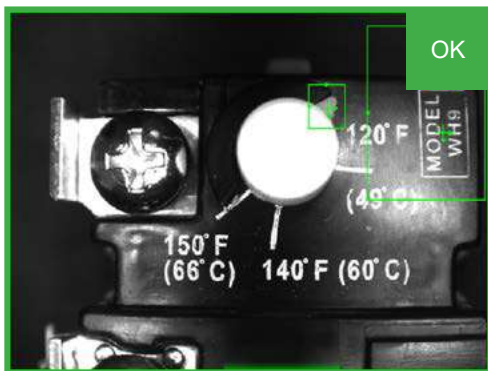

The dial on a thermostat is checked to confirm that it is in the correct position, which helps to ensure proper installation.

AUTOMOTIVE



A fuel filter assembly is checked for the presence of an O-ring installed in the proper location before final packaging.

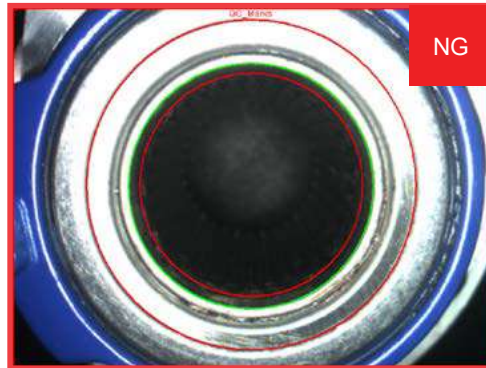
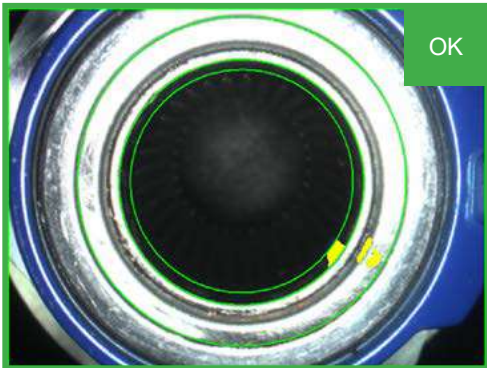

A wheel hub bearing is checked for the presence of quality control (QC) marks before moving to the next stage of assembly. The absence of the QC marks indicates that the hub bearing has not yet been inspected.



A fuel bowl gasket is inspected to verify that all 13 through holes have been punched out. A missing hole will cause the part to fail.

FOOD AND BEVERAGE



In-Sight vision sensors allow you to perform multiple inspections with each image. In this example, a bottle passes in front of the sensor, and both fill level and cap assembly are validated before the product is packaged.



A color pixel count tool verifies that the correct fruit snack flavor is present to ensure that it is packaged in the correct order.

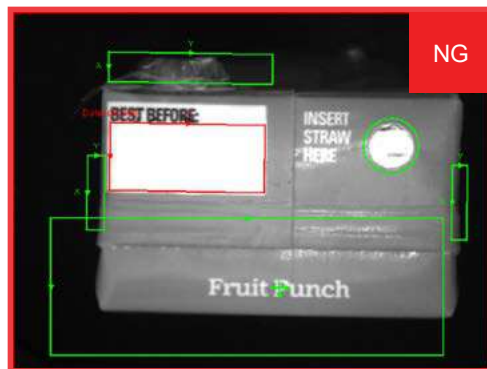

Inspections on a juice box verify that the date/lot code has been printed, confirm the safety seal is intact, check for the presence of a straw, and confirm that the flaps are fully secured.

CONSUMER PRODUCTS

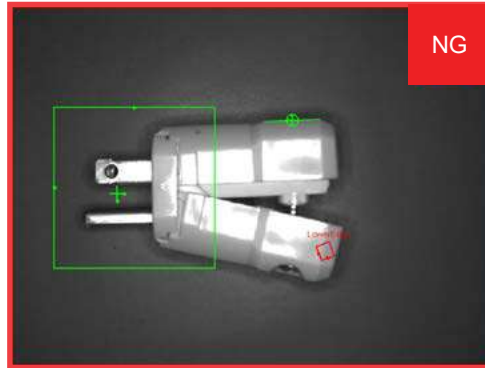
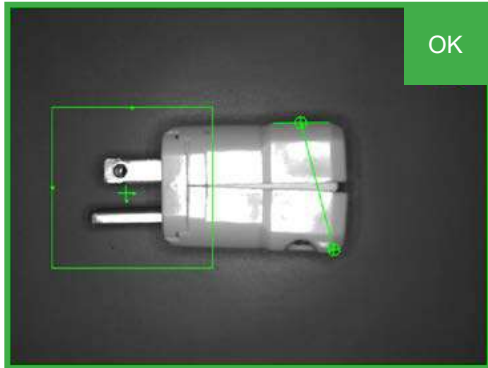

The distance between the two halves of an enclosure is measured to verify that the electrical plug has been assembled correctly. An open plug will cause a failure in the downstream packaging equipment.

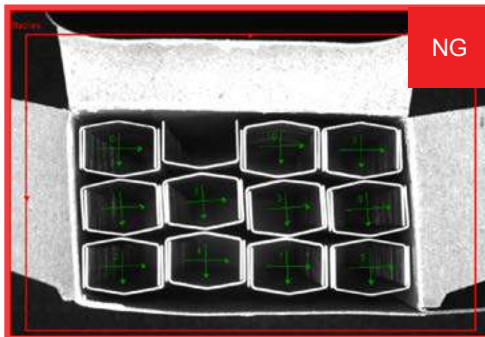
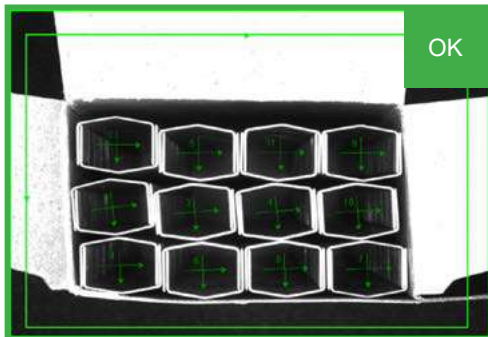

A pattern counting tool is used in this example to inspect the carton and to verify that the correct number of staple strips have been added.

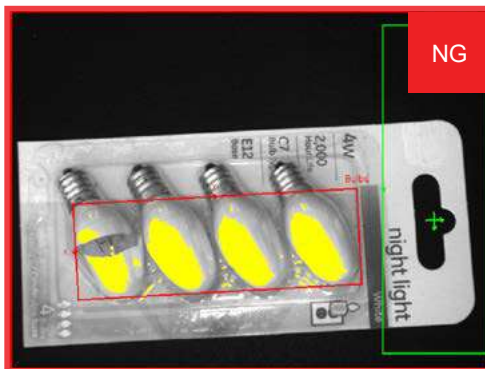
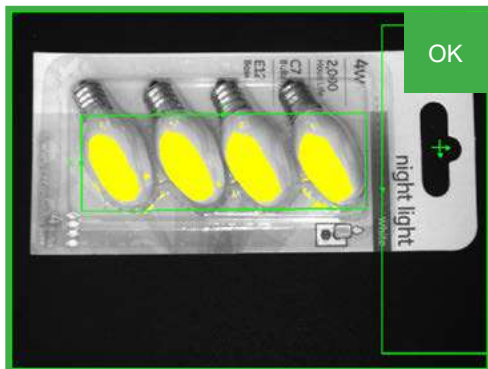

A package of light bulbs is inspected to confirm that all 4 bulbs are present and that none of the bulbs are broken.

HEALTH AND PHARMACEUTICALS

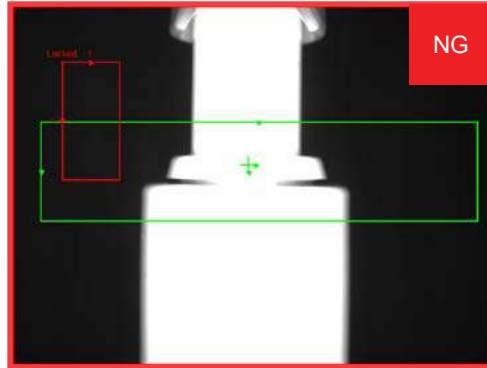
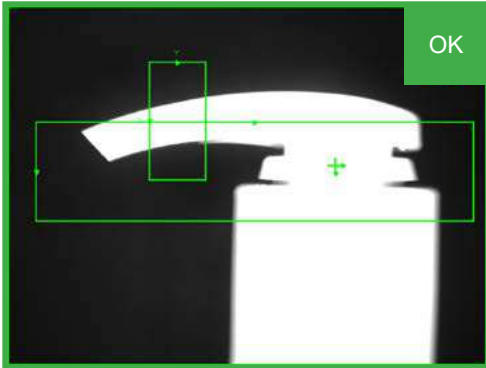

A lotion bottle is checked to confirm that the pump dispenser is in the locked position before the bottle is packed into a carton.

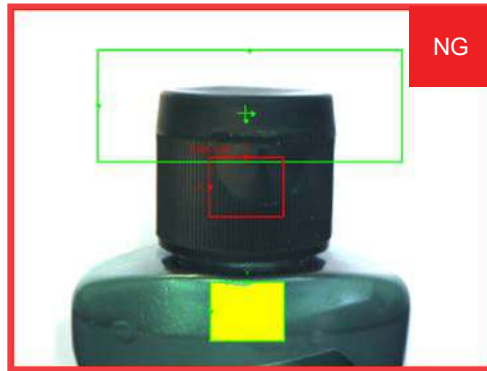
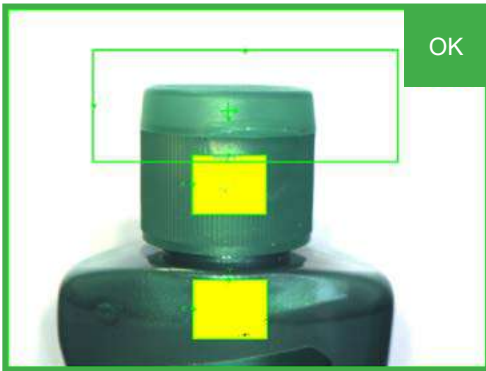

A shampoo bottle is inspected to confirm that the cap and bottle colors match.

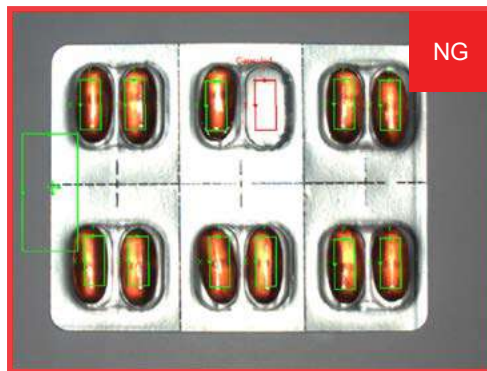

A blister pack is inspected to verify that all the capsules are present after sealing.

Modular Design

In-Sight 2000 series models include an integrated lens and LED illumination that eliminate the need for costly external lighting. Lenses and lighting are field-interchangeable to adjust to different application requirements. The In-Sight 2000 Mini has a smaller form factor making it ideal for mounting in tight spaces.

In-Sight 2000

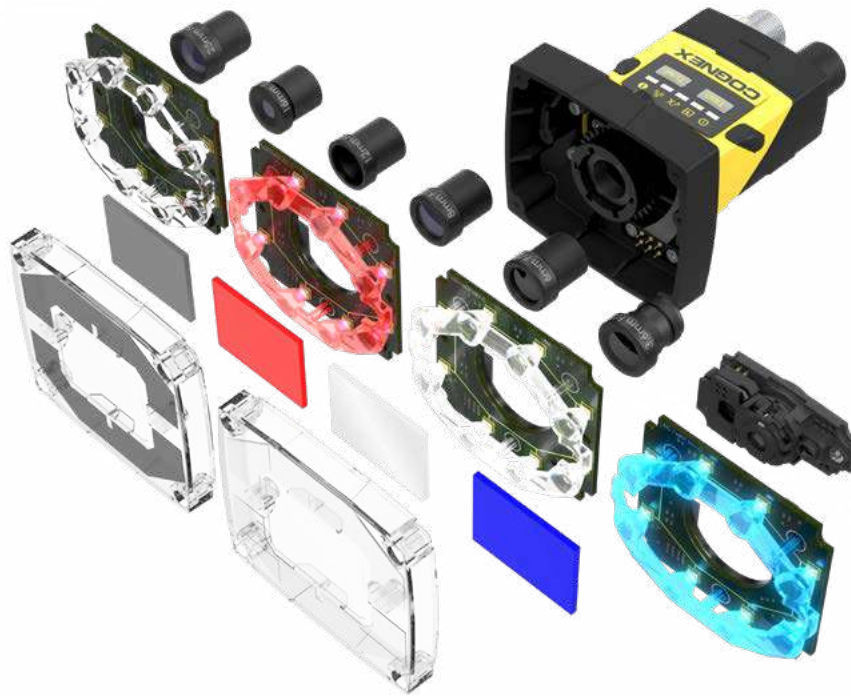

In-Sight 2000 Mini



A Model for Any Application

Available in both monochrome and color image models, and with different combinations of vision tools, the In-Sight 2000 series lets you choose the level of capability you need. Whatever your inspection application, there's an In-Sight 2000 vision sensor model that's right for the job.

IN-SIGHT 2000 MODELS

		2000-110	2000-120	2000-130	2000-230
User Interface ¹		In-Sight Explorer EasyBuilder			
1/3" CMOS Imager, Global Shutter		Monochrome	Monochrome and Color		
S-Mount/M12 Lenses		Standard: Autofocus (liquid lens) 6.2 mm or manual focus 8 mm Optional: Manual focus 3.6 mm, 6 mm, 12 mm, 16 mm, 25 mm			
Image Modes	640 x 480 (standard)	✓	✓	✓	✓
	640 x 480 (2x magnification)	✗	✓	✓	✓
	800 x 600 (2x magnification)	✗	✗	✓	✓
	1280 x 960 ²	✗	✗	✗	✓
Lighting	Standard	Diffuse white LED ring light			
	Options	Red, blue and IR LED ring lights and lens filters, and polarized light cover			
Maximum Acquisition Speed ³		40 fps	75 fps (M) and 55 fps (C)		
Relative Processing Speed		1x	2x	2x	2x
Location Tools	Pattern	✓	✓	✓	✓
	Edge, Circle	✗	✗	✓	✓
Inspection Tools	Pattern	✓	✓	✓	✓
	Pixel Count	✗	✓	✓	✓
	Brightness & Contrast	✗	✓	✓	✓
	Edges	✗	✗	✓	✓
Measurement & Counting Tools	Distance, Angle & Diameter	✗	✗	✓	✓
	Patterns & Edges	✗	✗	✓	✓
Advanced Features	OCR	✗	✗	✗	✓
	Blob Detection	✗	✗	✗	✓
	Image Filters	✗	✗	✗	✓
Data Output		Pass/Fail		Pass/Fail, Numeric ⁴	Pass/Fail, Numeric
Communications & I/O	Protocols	EtherNet/IP, PROFINET, SLMP, SLMP Scanner, Modbus TCP, TCP/IP, UDP, FTP, Telnet (Native Mode), RS-232			
	Connectors	(1) Industrial M12 Ethernet, (1) M12 Power & I/O			
	Inputs & Outputs	(1) Acquisition trigger, (1) General purpose input ⁵ , (4) General purpose outputs ⁵			
Mechanical	Dimensions	In-line configuration: 92 mm (3.61 in) x 60 mm (2.38 in) x 52 mm (2.05 in) Right-angle configuration: 61 mm (2.42 in) x 60 mm (2.38 in) x 52 mm (2.05 in)			
	Weight	200 g (7.05 oz)			
	Material and Protection	Painted aluminum, IP65-rated housing			
Operating	Power	24 VDC ±10%, 48 W (2.0 A) maximum when the illumination is on			
	PoE Configuration Available	✗	✓	✓	✓
	Temperature	0 °C to 40 °C (32 °F to 104 °F)			

¹ Compatible with Cognex VisionView 900 HMI touchscreen panel and VisionView PC Software.

² Available in select regions. Ask your Cognex sales representative for more information.

³ Maximum framerate with minimum exposure; no vision tools; and 640 x 480 image with 2x Image Magnification enabled (for 2000-120/130/230 models).

⁴ Limited to Measurement & Counting Tools only.

⁵ (7) general purpose inputs and (8) general purpose outputs when using optional CIO-1400 I/O Expansion Module.

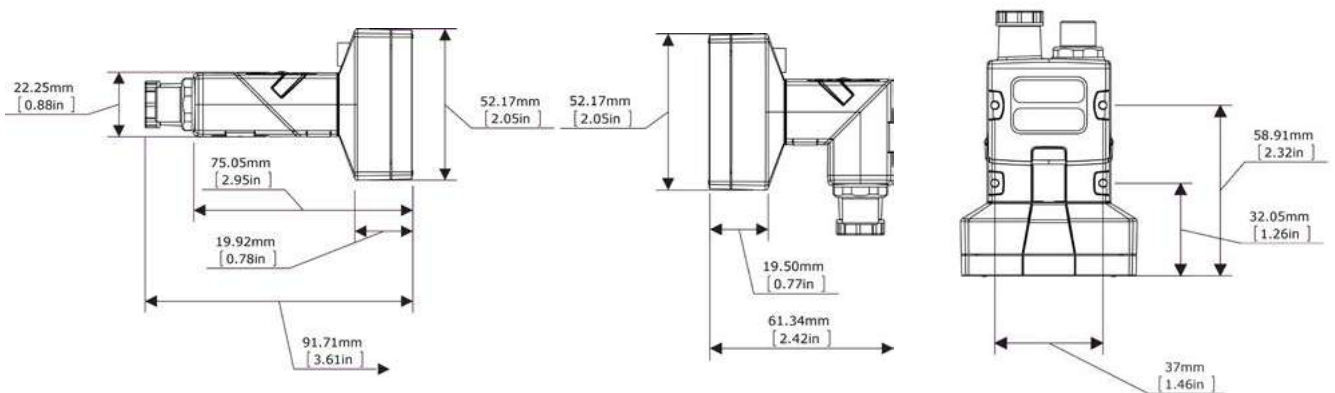

IN-SIGHT 2000 MINI MODELS

		2000-110 Mini	2000-120 Mini	2000-130 Mini	2000-230 Mini
User Interface ¹		In-Sight Explorer EasyBuilder			
1/3" CMOS Imager, Global Shutter		Monochrome	Monochrome and Color		
S-Mount/M12 Lenses		Standard: Autofocus (liquid lens) 6.2 mm or 16 mm			
Image Modes	640 x 480 (standard)	✓	✓	✓	✓
	640 x 480 (2x magnification)	✗	✓	✓	✓
	800 x 600 (2x magnification)	✗	✗	✓	✓
	1280 x 960 ²	✗	✗	✗	✓
Lighting	Standard	Modular red LEDs	Modular red and white LEDs		
	Options	White, blue & IR LED lights, band-pass filters & polarizing filter	White, blue & IR LED lights, band-pass filters, polarizing filter, and polarized light cover		
Maximum Acquisition Speed ³		40 fps	75 fps (M) and 55 fps (C)		
Relative Processing Speed		1x	2x	2x	2x
Location Tools	Pattern	✓	✓	✓	✓
	Edge, Circle	✗	✗	✓	✓
Inspection Tools	Pattern	✓	✓	✓	✓
	Pixel Count	✗	✓	✓	✓
	Brightness & Contrast	✗	✓	✓	✓
	Edges	✗	✗	✓	✓
Measurement & Counting Tools	Distance, Angle & Diameter	✗	✗	✓	✓
	Patterns & Edges	✗	✗	✓	✓
Advanced Features	OCR	✗	✗	✗	✓
	Blob Detection	✗	✗	✗	✓
	Image Filters	✗	✗	✗	✓
Data Output		Pass/Fail		Pass/Fail, Numeric ⁴	Pass/Fail, Numeric
Communications & I/O	Protocols	EtherNet/IP, PROFINET, SLMP, SLMP Scanner, Modbus TCP, TCP/IP, UDP, FTP, Telnet (Native Mode), RS-232			
	Connectors	(1) Industrial M12 Ethernet, (1) M12 Power & I/O			
	Inputs & Outputs	(1) Acquisition trigger, (1) General purpose input ⁵ , (4) General purpose outputs ⁵			
Mechanical	Dimensions	In-line configuration: 43.1 mm (1.69 in) x 22.4 mm (0.88 in) x 64 mm (2.51 in) Right-angle configuration: 43.1 mm (1.69 in) x 35.8 mm (1.40 in) x 49.3 mm (1.94 in)			
	Weight	142 g (5 oz)			
	Material and Protection	Painted aluminum, IP65-rated housing			
Operating	Power	24 VDC ±10%, <3.0 W			
	PoE Configuration Available	✗	✓	✓	✓
	Temperature	0 °C to 40 °C (32 °F to 104 °F)			

¹ Compatible with Cognex VisionView 900 HMI touchscreen panel and VisionView PC Software.

² Available in select regions. Ask your Cognex sales representative for more information.

³ Maximum framerate with minimum exposure; no vision tools; and 640 x 480 image with 2x Image Magnification enabled (for 2000-120/130/230 models)

⁴ Limited to Measurement & Counting Tools.

⁵ (7) general purpose inputs and (8) general purpose outputs when using optional CIO-1400 I/O Expansion Module.

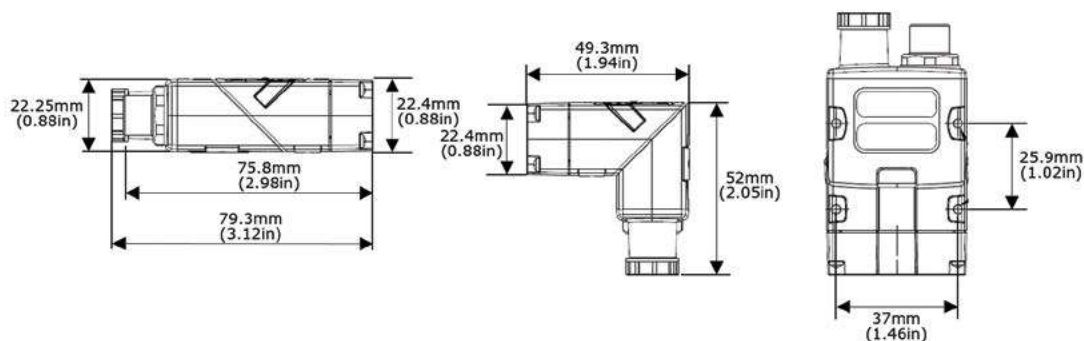

Flexible Mounting Configurations

In-Sight vision sensors can be configured for in-line and right-angle mounting installation. This modular body design provides maximum flexibility to mount in tight spaces, simplifies wiring and optical paths, and minimizes the need to design new mechanical fixtures.



Field of View Options

In-Sight 2000 vision sensors support a wide variety of modular lens options, making it easy to choose the correct configuration for your work cell. Simply choose the desired working distance and the minimum field of view to determine the appropriate lens. This will minimize the amount of time spent choosing and troubleshooting accessories for the application.

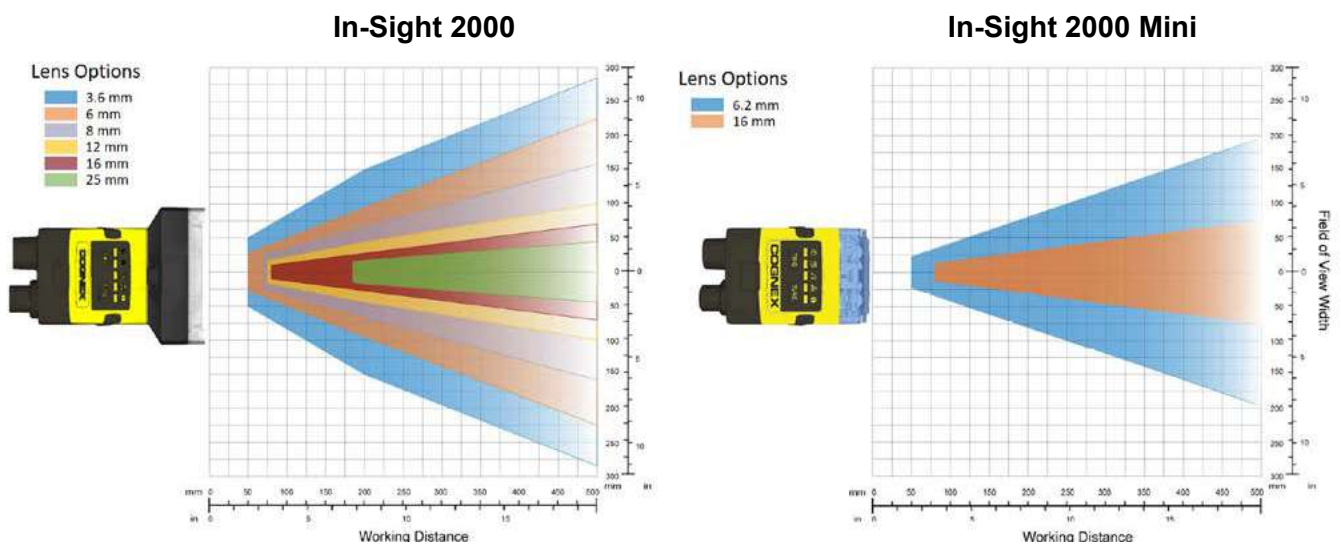

BUILD YOUR VISION

2D VISION

Cognex machine vision systems are unmatched in their ability to inspect, identify and guide parts. They are easy to deploy and provide reliable, repeatable performance for the most challenging applications.

www.cognex.com/machine-vision



3D VISION

Cognex In-Sight laser profilers and 3D vision systems provide ultimate ease of use, power and flexibility to achieve reliable and accurate measurement results for the most challenging 3D applications.

www.cognex.com/3D-vision-systems



VISION SOFTWARE

Cognex vision software provides industry leading vision technologies, from traditional machine vision to deep learning-based image analysis, to meet any development needs.

www.cognex.com/vision-software



BARCODE READERS

Cognex industrial barcode readers and mobile terminals with patented algorithms provide the highest read rates for 1D, 2D and DPM codes regardless of the barcode symbology, size, quality, printing method or surface.

www.cognex.com/BarcodeReaders



COGNEX

Companies around the world rely on Cognex vision and barcode reading to optimize quality, drive down costs and control traceability.

Corporate Headquarters One Vision Drive Natick, MA 01760 USA

Regional Sales Offices

Americas

North America +1 844-999-2469
Brazil +55 (11) 2626 7301
Mexico +01 800 733 4116

Europe

Austria +49 721 958 8052
Belgium +32 289 370 75
France +33 1 7654 9318
Germany +49 721 958 8052

Hungary +36 800 80291
Ireland +44 121 29 65 163
Italy +39 02 3057 8196
Netherlands +31 207 941 398
Poland +48 717 121 086
Spain +34 93 299 28 14
Sweden +46 21 14 55 88
Switzerland +41 445 788 877
Turkey +90 216 900 1696
United Kingdom +44 121 29 65 163

Asia

China +86 21 6208 1133
India +9120 4014 7840
Japan +81 3 5977 5400
Korea +82 2 539 9980
Malaysia +6019 916 5532
Singapore +65 632 55 700
Taiwan +886 3 578 0060
Thailand +66 88 7978924
Vietnam +84 2444 583358

www.cognex.com

© Copyright 2019, Cognex Corporation. All information in this document is subject to change without notice. All Rights Reserved. Cognex, In-Sight, EasyBuilder, and VisionView are registered trademarks of Cognex Corporation. Build Your Vision and In-Sight Explorer are trademarks of Cognex Corporation. All other trademarks are property of their respective owners. Lit. No. SG-EN-052019